

GS (spring return) pneumatic actuator 50 PSI ÷ 3,5 bar

Macro Pneumatic actuators

Category Special version on request

On request



benefits

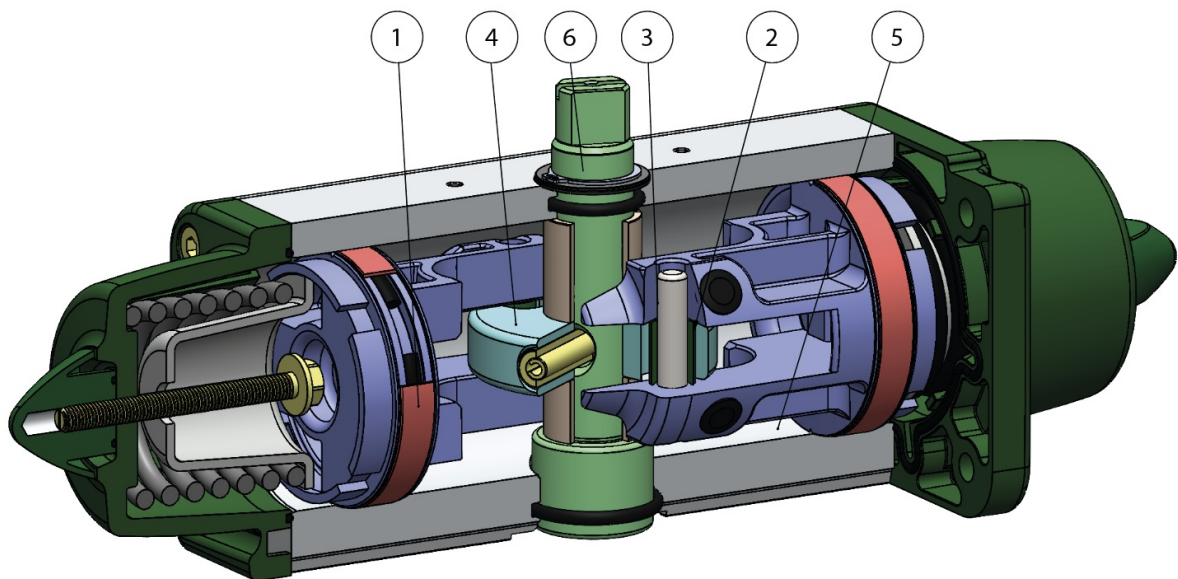

1. Energized and self-lubricated strips

Less friction between piston and cylinder
It prevents the bonding of the seal to the cylinder even after long periods of inactivity

2. Slots, bushes and pins made by steel with hardness higher than 50 HRC

Higher resistance to the forces inside the actuator

3. Rolling friction between piston and slot

Less friction

4. Scotch yoke with rolling friction (transforming rotary motion into linear motion using piston and shaft without teeth/gears)

Reduced friction between piston and shaft with consequently less wear on the relevant parts
Empowered Breakaway Torque (BTO & BTC)
Smaller volume/size than rack and pinion actuators (with the same torque) therefore less space required for installation
Less weight than the rack and pinion (-30% kg / Nm), with consequent savings on the construction sizing of the plant/equipment
Lower air consumption compared to the rack and pinion actuators (-40% air cm³/Nm for Double Acting and -20% air cm³/Nm for Spring Return) therefore less load on the compressor or the possibility of using a smaller compressor's size.

5. Rolled cylinder

Less wear of the energized ties thanks to the low roughness of the surface

6. Stainless steel shaft

Higher corrosion resistance

From sizes bigger than GD15, NAMUR interface for solenoid valve is already integrated

No need for extra plate.

100% in- house manufacturing process technology

Maximum control and accuracy in all the stages of the manufacturing process

ATEX Certificate

Installation is allowed in a potential explosive environment

Up to SIL 3 Certified

Guarantee of the high level of functional safety.

accessories

LIMIT SWITCH BOX



MANUAL OVERRIDE WITH HAND WHEEL



NAMUR SOLENOID VALVES



SOLENOID VALVES



ELECTROPNEUMATIC POSITIONER (INTRINSICALLY SAFE)

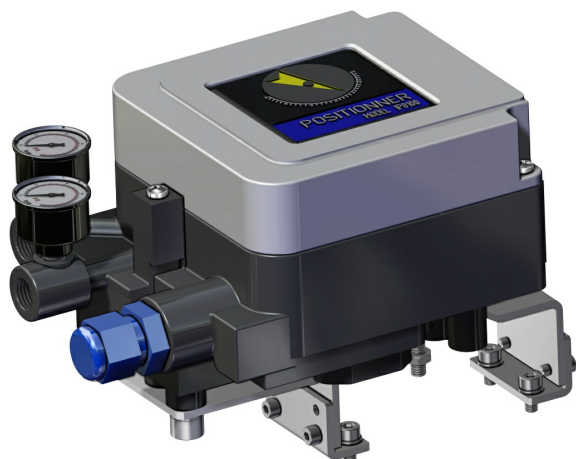

PNEUMATIC POSITIONER



PROXIMITY LIMIT SWITCHES

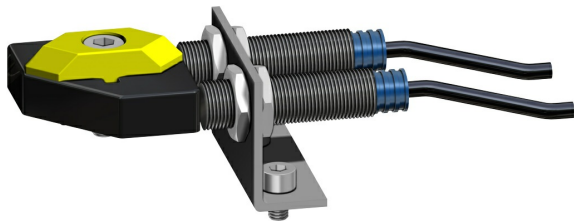

ELECTROMECHANICAL LIMIT SWITCHES

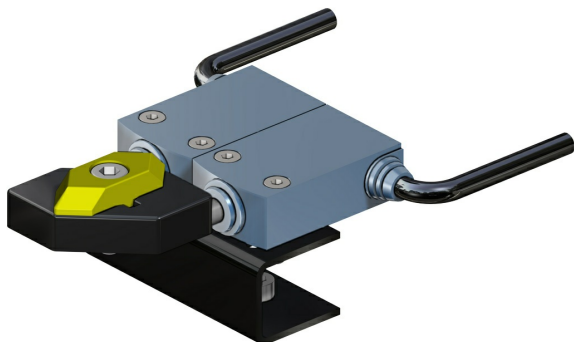

PNEUMATIC LIMIT SWITCHES

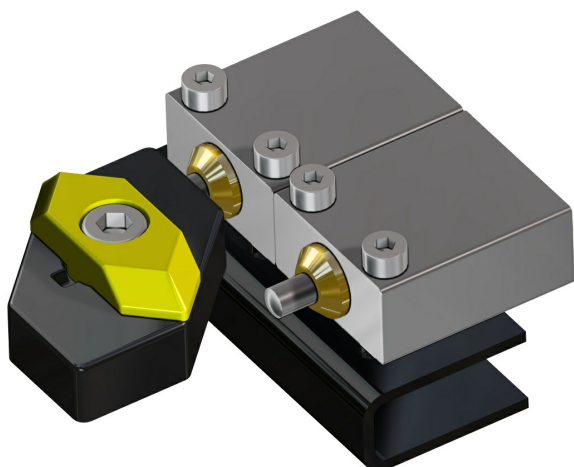

EXPLOSION PROOF LIMIT SWITCHES II2GD ExdIIC

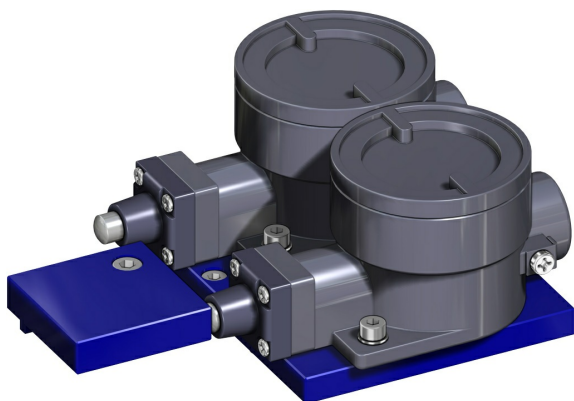

For more information check the ACTUATECH Accessories Catalogue.