

VNC20007

Pneumatic valves - VIP - Pneumatic Coaxial
 Valve Spring return N.C. FKM DN 32 1" 1/4

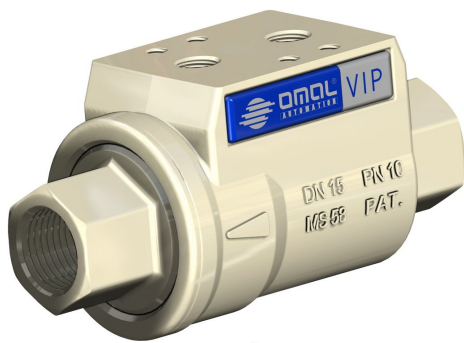

Drive: Spring return N.C.
 Liner: FKM
 Size: DN 32 1" 1/4

176,50 € Excl. VAT
 list price

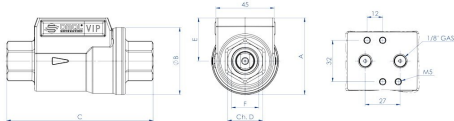

Article	Nominal pressure	Weight [kg]	Variant	Spare part kit
VNC20007	PN 10	3.41	Ottone	KGVV0107

GENERAL INFO

VIP - Pneumatic Coaxial Valve

benefits

**WHILE
STOCKS
LAST**

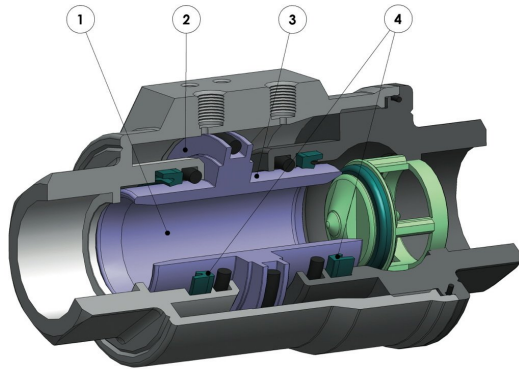

1. Internal diameter equal to the diameter of the pipe

High flow capacity

2. Pneumatic actuator integrated in the valve

Space saving (-60%) and reduced costs compared to an automated valve

3. Piston with chemical nickel plating (20-25 micron)

Lower wear of the seals due to the increase of the surface hardness (400 -550 HV)

4. Lip seals

Less wear of the seal comparing with an o-ring

Several seal materials available

Maximum compatibility with different types of fluids depending by the seals used

No external moving parts

Maximum safety
Easy mounting

Long life time granted

Lifetime 10 times longer than a ball valve with reduced maintenance costs

100% in- house manufacturing process technology

Maximum control and accuracy in all the stages of the manufacturing process

Less Air consumption

80% less air consumption compared to an actuated valve with SR pneumatic actuator therefore less load on the compressor or the possibility of using a smaller compressor's size.

ATEX Certificate

Installation is allowed in a potential explosive environment

PED Certificate

Full compliance with European Safety Standards for Pressure Equipment

features

GENERAL FEATURES:

Both Double Acting and Spring Return VIP valves (either Normally Open or Normally Closed) are available in sizes ranging from 3/8" to 2". Unidirectional flow.

GAS threaded ends as per EN 10226-1 Rp (Ex ISO 7/1) - DIN 2999 (NPT threads on request) with control fluid connections as per NAMUR interface.

Improved fluid dynamics allow minimum pressure losses. See Flow Pressure Diagram.

VIP valves can be used in any mounting position (horizontal, vertical or oblique).

They can be provided with seals in NBR, FKM or EPDM:

- NBR: suitable for air, gas, oils, water etc..
- FKM: perfectly suitable for most fluid. Unsuitable for steam.
- EPDM: perfectly suitable for hot water and steam. Unsuitable for mineral products (oils, grease, etc..).

For further information about gas, explosive fluids, material compatibilities etc. please contact our technical department.

Possibility to check open / close valve position thanks to inductive limit switches (magnetic contact) available on request. Internal magnet needs to be requested at VIP order phase.

According to 2014/68/EU "PED".

2014/34/EU ATEX configuration to request at time of order.

CONTROL MEDIA:

Filtered compressed air, not necessarily lubricated. At temperatures from -20°C to 0°C, use dry air. In case of lubricated air, seal compatible oil must be used.

Air supply:

3 bar min.- 8 bar max. in Double Acting execution.

4,2 bar min.- 8 bar max. in Spring Return execution.

OPERATING MEDIA:

Pressure: 10 bar max, see diagram

Temperature: from -20°C to +80°C (NBR); from -20°C to +150°C (FKM); from -20°C to +150°C (EPDM).

Vacuum tightness: 97% vacuum (about 30 mbar absolut, -980 mbarg)

dimensions

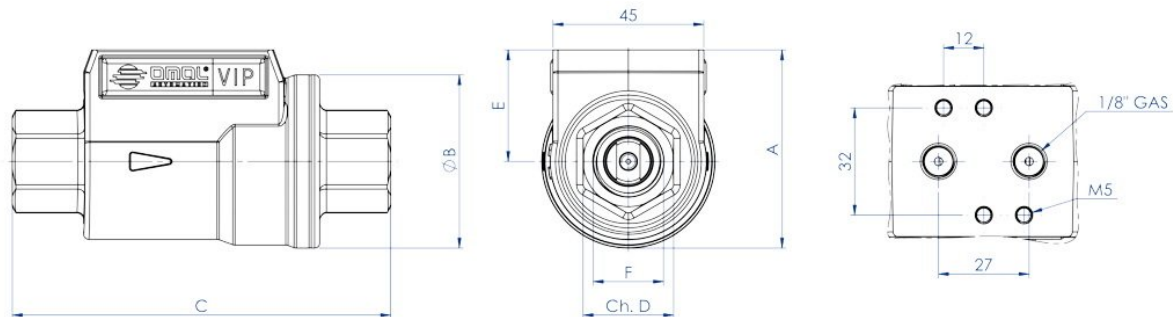

DIMENSIONS							
DN nominal diameter mm.	10	15	20	25	32	40	50
size F GAS.	3/8"	1/2"	3/4"	1"	1 1/4"	1 1/2"	2"
bore mm.	10	15	20	25	32	40	50
A mm.	54	60	70	76	92	102	115
øB mm.	46	51,7	63,5	69	86	96	109
C mm.	98	112	135	143	165	180	207
ch. D mm.	22	27	33	41	50	60	75
E mm.	31	34	39	42	49	54	60
double acting air dm ³ /cycle	0,024	0,035	0,063	0,080	0,150	0,219	0,310
spring return air dm ³ /cycle	0,012	0,017	0,031	0,040	0,075	0,109	0,155
weight double acting "DA" Kg.	0,80	1	1,59	1,8	3,13	3,5	5,5
weight spring return "SR" Kg.	0,85	1,05	1,69	1,88	3,41	3,7	5,8

materials

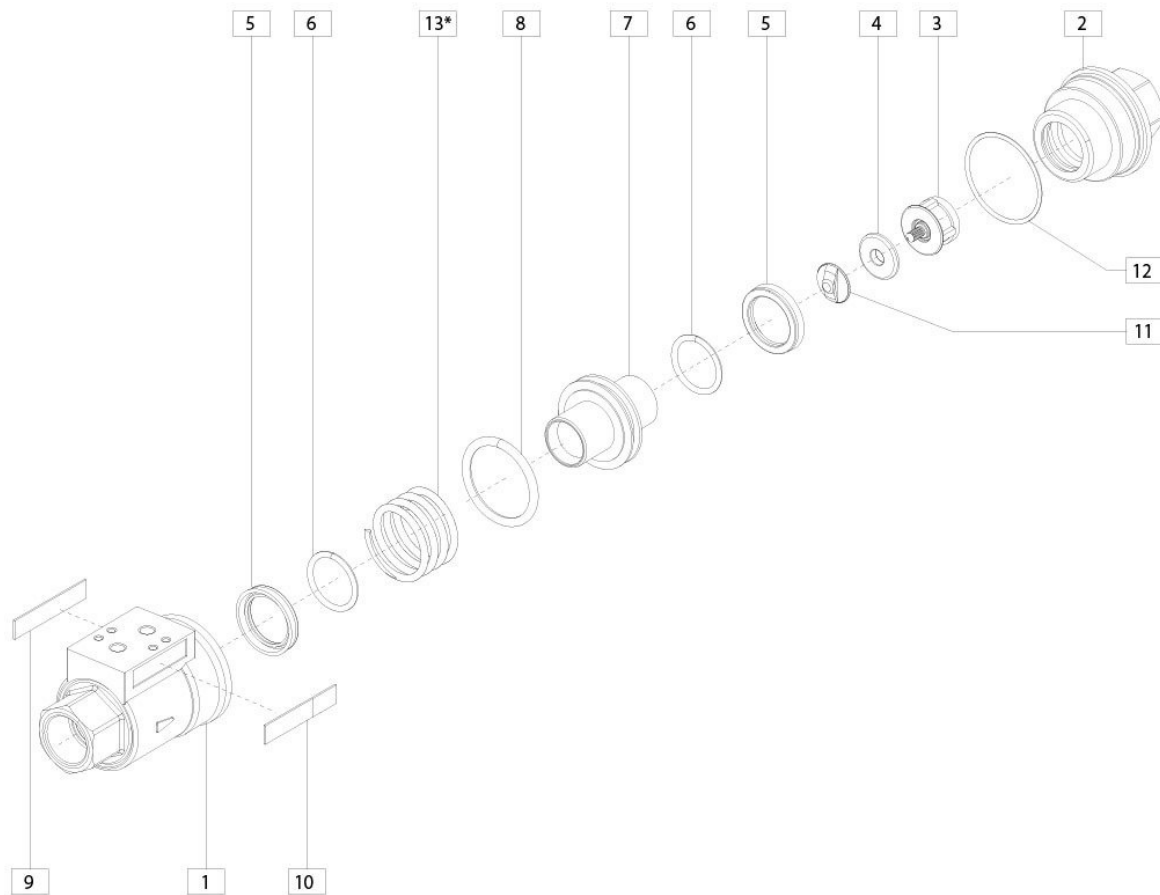

MATERIALS				
Pos.	Description	Q.ty	Material	Treatment
1	Body	1	Brass CW617N	nickel plated
2	Sleeve	1	Brass CW617N	nickel plated
3	Seat	1	Brass CW617N	nickel plated
4**	Seat-seal	1	NBR/FKM/EPDM	
5**	Lip seal	2	NBR/FKM/EPDM	
6**	O-ring	2	NBR/FKM/EPDM	
7	Piston	1	Brass CW617N	nickel plated
8**	Piston O-ring	1	NBR/FKM/EPDM	
9	Technical label	1	Polyestere	
10	OMAL label	1	Polyestere	
11	Seat nut	1	Brass CW614N	nickel plated
12**	Sleeve O-ring	1	NBR/FKM/EPDM	
13	Spring (only for SR)	1	Stainless steel	

**Components of spare part kit

diagrams and working plan

DIAGRAMMA PORTATA - PERDITA DI CARICO E COEFFICIENTE NOMINALE
 FLOW PRESSURE DROP DIAGRAM AND Kv NOMINAL COEFFICIENT

Il valore Kv è il valore di portata in m³/h (con acqua a 15°C) provocante la caduta di pressione di 1 bar.
 Kv is the coefficient, expressed in m³/h (with water at 15°C) causing a pressure loss of 1 bar.



DIAGRAMMA PRESSIONE TEMPERATURA VIP EPDM
 VIP EPDM PRESSURE TEMPERATURE DIAGRAM



DIAGRAMMA PRESSIONE TEMPERATURA VIP NBR
 VIP NBR PRESSURE TEMPERATURE DIAGRAM

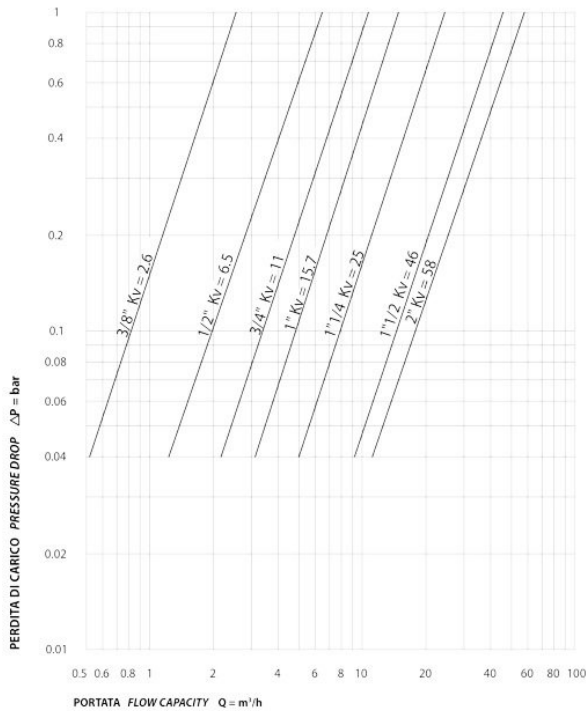

DIAGRAMMA PRESSIONE TEMPERATURA VIP FKM
 VIP FPM PRESSURE TEMPERATURE DIAGRAM

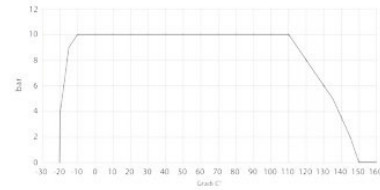

SCHEMI DI FUNZIONAMENTO WORKING PLAN

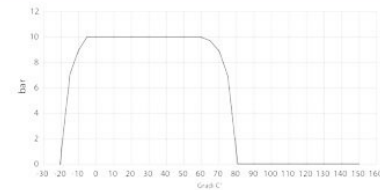
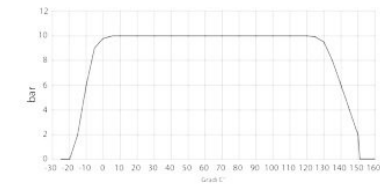
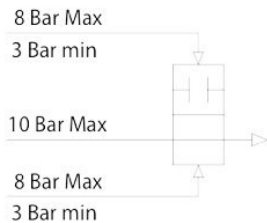

Schema di funzionamento nella configurazione
 doppio effetto

Double acting VIP Working plan

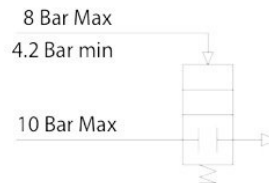

Schema di funzionamento nella configurazione
 semplice effetto normalmente chiuso

Spring return Normally closed VIP
 Working plan

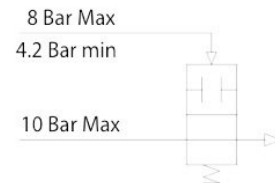

Schema di funzionamento nella configurazione
 semplice effetto normalmente aperto

Spring return Normally open VIP
 Working plan

specifications

WORKING PRINCIPLE

A VIP valve (patented by OMAL exclusively) is a proper automatic valve embodying both interception device (between pipe C-D) and control device (A-B).

It works thanks to the internal movement of a piston supplied with air. At the end of its stroke (a VIP valve is an ON/OFF valve), the piston presses on the seat seal or moves away from it letting the intercepted fluid flow or stopping it from flowing. As the seat is perfectly tight and the intercepted fluid pressures discharge on it, the pressure necessary to move the piston is completely independent of the fluid pressure. As a result OMAL has been able to design a light space saving and lasting valve. Its full bore and its improved internal dynamics allow minimum pressure losses, too.

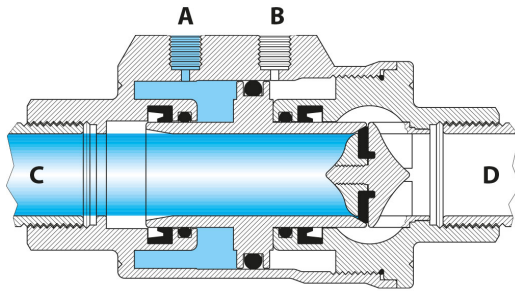

Closed valve

Supplying the hole "A" with air (the hole "B" must be discharging) at the end of its stroke the piston presses on the seat seal: the valve is closed.

As in Spring Return N.C. executions the spring is in "A", if there is no control, the piston will touch the seat seal: therefore, the preferable position is the closed one.

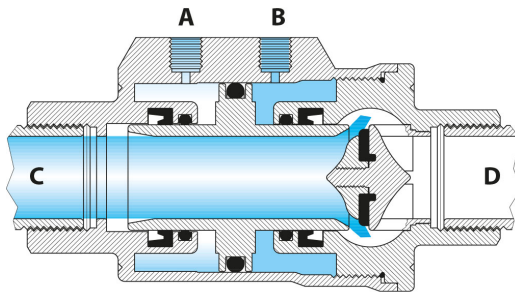

Transitional phase

During the transitional phase (the picture shows the opening transition in a Double Acting execution), one of the two holes is supplied. The piston moves axially changing the previous closed or open state. In Spring Return N.C. executions, the closing is caused by the spring (if there is no control). In Spring Return N.O. executions, the opening is caused by the spring (if there is no control). Both opening and closing transitional phases last less than a second.

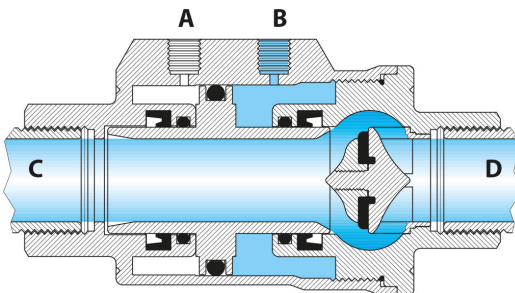

Opened valve

Supplying the hole "B" with air (the hole "A" must be discharging) at the end of its stroke the piston is at maximum distance from the seat seal: the valve is open.

As in Spring Return N.O. executions the spring is in "B", if there is no control, the piston will be away from the seat seal: therefore, the preferable position is the open one.

accessories

VIP with NAMUR solenoid valve

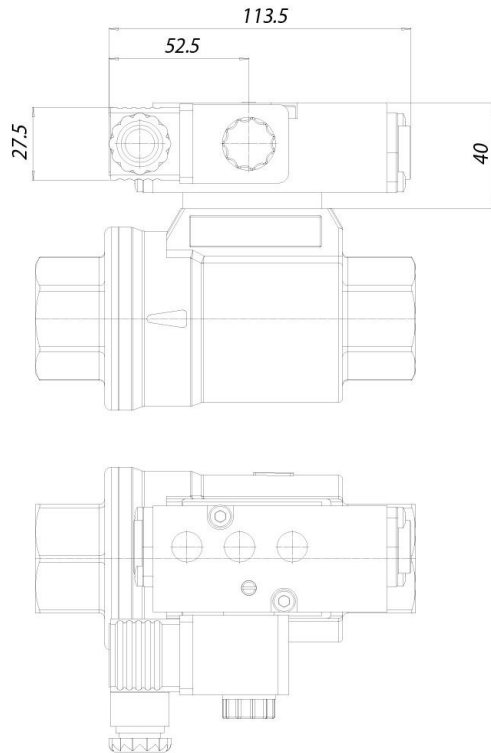

Solenoid valve 5/2 as per NAMUR

This solenoid valve is designed for the selection of the functions 5/2 and

3/2, which is realized by using the appropriate plate.

Full-working input power - D.C.: 2,5 W

Full-working input power - A.C.: 2 W

Supply voltage tolerances: +/- 10%

Coil insulation: F-class

Protection with connector: IP65

Electric connection: PG 9

Pneumatic connections: inlet 1/4"; outlet 1/4" ISO 228

Max. pressure: 10 bar

Operating media temperature: from -10°C to +80°C

Ambient temperature: from -10°C to +50°C

NAMUR SOLENOID VALVE

Solenoid valve	ER8188A2	ER8188A4	ER8188A5	ER8188C2	ER8188C4
Voltage	24V AC	115V AC	230V AC	24V DC	110V DC

VIP with microsolenoid valve

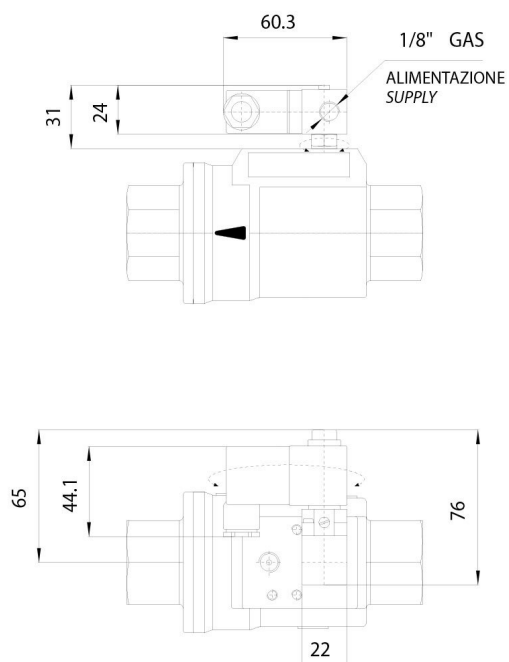

Micro solenoid valve :

This solenoid valve is connected by a joint which fits directly to the actuator air intake, without other fittings or fixing screws.

3/2 solenoid valve, with solenoid available in the following voltages: 24-110-220V AC; 12-24V DC.

Starting input power - A.C.: 9 VA

Full-working input power - D.C.: 5 W

Full-working input power - A.C.: 6 VA

Supply voltage tolerances: +/- 10%

Copper wire insulation: H-class

Coil insulation: F-class

Protection with connector: IP65

Electric connection: PG 9 any orientation acceptable 360°

Pneumatic connections: 1/8" ISO 228 any orientation acceptable 360°

Max. pressure: 10 bar

Operating media temperature: from -10°C to +50°C

Ambient temperature: from -10°C to +50°C

ø Bore 1,3 mm

MICRO SOLENOID VALVE					
Solenoid valve	EP415024	EP415110	EP415220	EP412012	EP412024
Voltage	24V AC	115V AC	230V AC	12V DC	24V DC

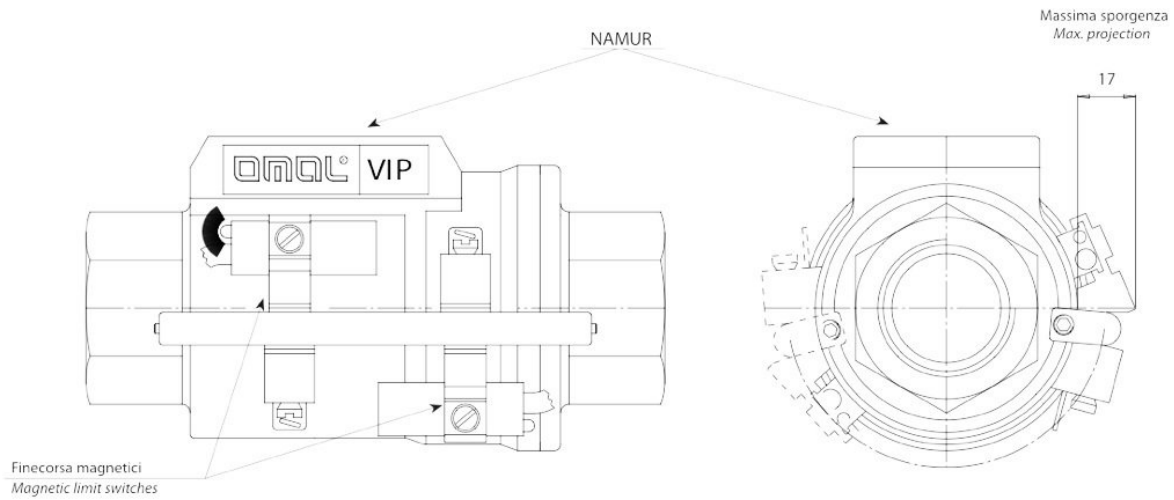

VIP can be provided with magnetic contact inductive limit switches and signalling LED. Limit switches are supplied with a KIT which makes it possible to fix them on the outside easily and quickly. **Since the magnets are situated inside the valve, they must be assembled while mounting the VIP and not afterwards. That's the reason why the limit switches must be requested on ordering the valve.**

Limit-switch electric plan

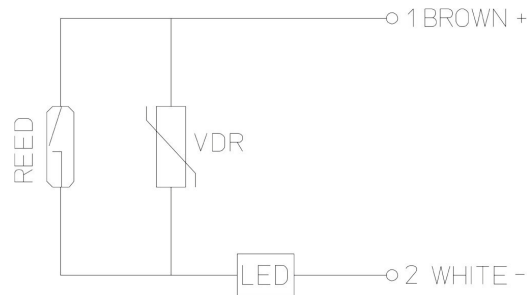

LIMIT-SWITCH ELECTRICAL FEATURES	
Switch indicator	LED
Protection level	IP 67
Nominal voltage with direct current	3÷250 V dc
Nominal voltage with alternating current	3÷250 V ac
Maximum voltage drop	2,5 V
Maximum power with direct current	50 W
Maximum power with alternating current	50 VA
Maximum current at 25°C (resistive load)	1 A
Protection against inductive tension peaks	250 VR
Inverse polarity protection	.
Maximum applicable load (coil with overvoltage suppressor)	10 W
Maximum applicable load (simple coil)	10 W
Maximum applicable load (PLC)	.
Electric life (resistive load 20% max. power short distance between load and switch)	10x10 ⁶
Repeatability	0,1 mm
Operating time (resistive load)	2 ms
TeRelease time (resistive load)	0,1 ms
Working temperature	-30÷+80 °C
Impact resistance (11ms)	50 g
Vibration resistance	1000 Hz
Sensor type	1
Connecting cable 2m	n° 2 fili

documents

Instructions

[ATEX MANUAL 8_0489-02](#)

[USER MANUAL 8_0841_12 - VIP](#)

[USER MANUAL UIT00A700X](#)

Certificates

[PED](#)

[ATEX - Pneumatic Valves](#)